

Suction Surgery

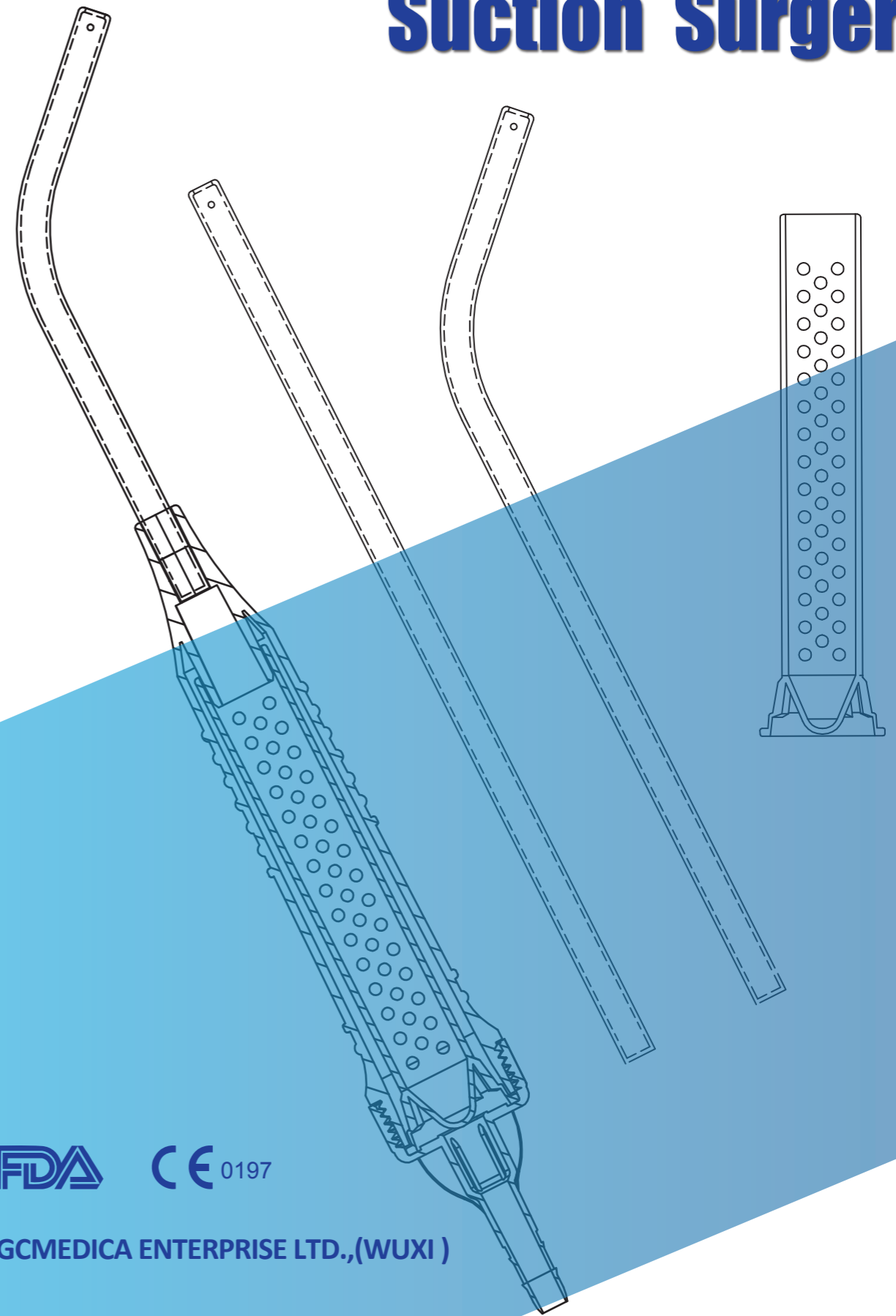

Adress: Loujin Industrial park, Shuofang, Wuxi, 214143, P.R.China



Tel: 86 510 8273 3513 Fax: 86 510 8273 0717



E-mail: info@gcmedica.com



Website: www.gcmedica.com



GCMEDICA ENTERPRISE LTD.,(WUXI)



CONTENTS

- ※ FLEXI-CLEAR YANKAUER HANDLE1~2
 - Super-smooth Distal1
 - Regular Distal2
 - Flexible2
 - Derby Rose Tipe2
- ※ YANKAUER HANDLE.....3~6
 - Plain Tip Yankauer3
 - Frange Tip Yankauer3
 - Tapered Tip Yankauer4
 - On/off Yankauer.....4
 - Bulb Tip Yankauer5
 - Crown Tip Yankauer5
 - Poole Suction Handle5
 - Plain Tip Yankauer6
 - Duck-bill Tip Yankauer6
- ※ ASPIRATOR SURGICAL TIP6
- ※ SUCTION PROBE.....7
 - Suction Probe with Male Connector.....7
 - Suction Probe-Flexible7
- ※ FRAZIER SUCTION TUBE8
- ※ SUCKER INTRACARDIAC8
- ※ ORTHOPEDIC SUCTION SET9
- ※ SUCTION CONNECTING TUBE.....10~11
 - Male Connectors10
 - Bulk Suction Connecting Tube11
 - Suction Bubble Tubing11
- ※ RIGID SUCTION CANISTERS12
- ※ SUCTION CANISTER SOFT LINERS12

GCMEDICA PROFILE

GCMEDICA Group founded in 1998 with a mission dedicating to all medical personnel and patients, combines many years of experience and expertise, GCMEDICA specializes in the manufacturing scientific research and development of disposable medical devices and advanced moulds. GCMEDICA have built up a leading group company concentrated in various products production with CE certificate and registered with FDA US. With persistent and diligent exploration, GCMEDICA extents the product ranges to Respiratory, Anesthesia, Urology, Surgery, Operating room, Gynecology products.

GCMEDICA located in new industrial zone-Wuxi, which owns excellent convenient transportation. GCMEDICA has building area of 10000 m² manufacture base which incorporates a 100,000-class clean room of 5500 m² and well-equipped laboratories. GCMEDICA mainly manufactures Class I, Class II and Class III disposable medical devices. The applied expertise of our R&D team ensures our latest products are always innovative.

GCMEDICA is a professional and 100% purely manufacturer, who with the whole manufacturing process completed within our plants, from design, manufacture to sterilization.

GCMEDICA upholds “devoted to improve the lives of the people” as its spirit of enterprise. Our commitment to social engagement and responsibility is an important aspect of our company culture and philosophy.

GCMEDICA keeps the concept of being oriented by science, technology and taking quality as life. Providing the reliable products and credit has always developed its advantage. Making the products as a faith, observing market is guides to lead GCMEDICA a world famous brand.

FLEXI-CLEAR YANKAUER HANDLE

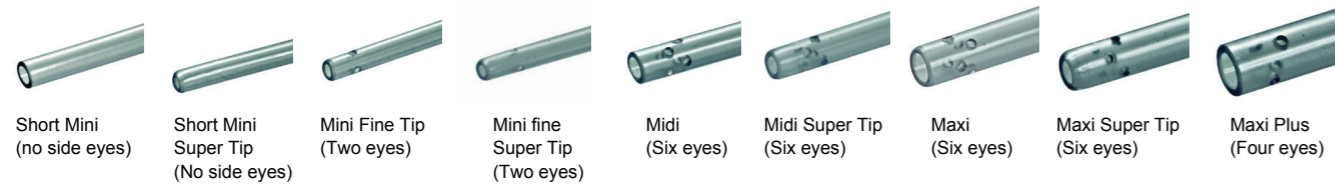
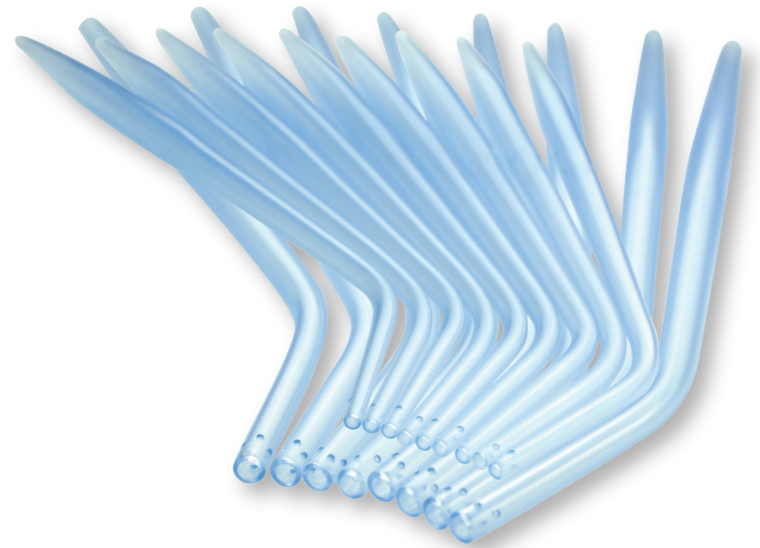

Short Mini (no side eyes) Short Mini Super Tip (No side eyes) Mini Fine Tip (Two eyes) Mini fine Super Tip (Two eyes) Midi (Six eyes) Midi Super Tip (Six eyes) Maxi (Six eyes) Maxi Super Tip (Six eyes) Maxi Plus (Four eyes)

FEATURES:

- Available with fine tip and super fine tip.
- Rigid tip or flexible tip for different application.

Super-smooth Distal

Rigid, transparent suction devices for use with suction connecting tubing. For general purpose surgical suctioning.

Product code	Size	Description
1202B4W1	Fr12	Mini fine super tip, with control vent
1202B4N1	Fr12	Mini fine super tip, without control vent
1202A5W1	Fr16	Short mini super tip, with control vent
1202A5N1	Fr16	Short mini super tip, without control vent
1202B5N1	Fr16	Mini fine super tip, without control vent
1202F6W1	Fr18	Maxi super tip, with control vent
1202F6N1	Fr18	Maxi super tip, without control vent
1202F7W1	Fr22	Maxi super tip, with control vent
1202F7N1	Fr22	Maxi Super tip, without control vent
1202F7W2	Fr22	Maxi tip, with control vent
1202F7N2	Fr22	Maxi tip, without control vent

Regular Distal

Product code	Size	Description
1202D9W2	Fr28	Maxi plus fine tip, with control vent
1202D9N2	Fr28	Maxi plus fine tip, without control vent

Flexible

Provides suction flexibility with clarity and visualization. Available in three tip styles: fine, regular and high. Vented and tubing options available with regular-capacity handle.

Product code	Size	Description
1206D4W1	Fr12	Maxi super tip with four lateral eyes, with control vent
1206D4N2	Fr12	Maxi tip with four lateral eyes, without control vent
1206A5W1	Fr16	Short mini super tip with no lateral eyes, with control vent
1206D5N1	Fr16	Maxi super tip with four lateral eyes, without control vent
1206D6W2	Fr18	Maxi Tip with four lateral eyes, with control vent
1206D6N1	Fr18	Maxi super tip with four lateral eyes, without control vent
1206C10N1	Fr30	Maxi plus super fine tip with four lateral eyes, without control vent

Derby Rose Tip

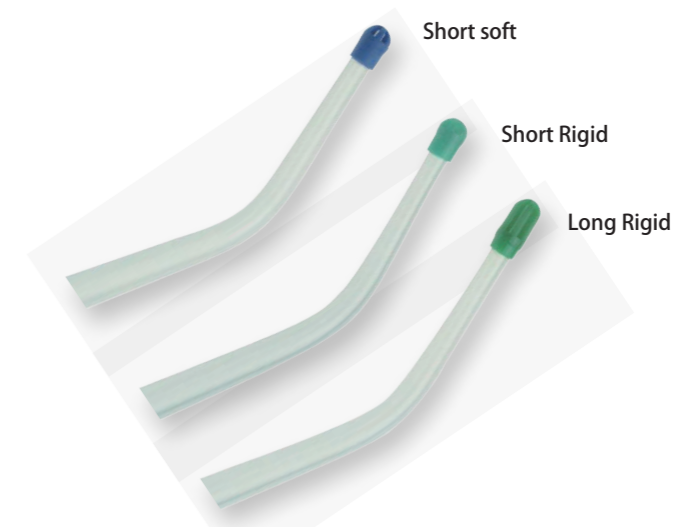

Product code	Size	Description
1207R6SW	Fr18	Tip short soft, with control vent
1207R6SN	Fr18	Tip short soft, without control vent
1207S6SW	Fr18	Tip short rigid, with control vent
1207S6SN	Fr18	Tip short rigid, without control vent
1207L6SW	Fr18	Tip long rigid, with control vent
1207L6SN	Fr18	Tip long rigid, without control vent

YANKAUER HANDLE

Suction Handles deliver performance and maneuverability. These lightweight handles are designed to provide optimal control and visibility while helping to minimize tissue trauma.

Plain Tip Yankauer

Clear, acrylic suction devices, similar to traditional yankauer suckers. With or without sump tip to reduce potential tissue suction during use.

Product code	Description
1219A3W	Small curved, with control vent, rigid
1219A3N	Small curved, without control vent, rigid
1219S3W	Big curved, with control vent, rigid
1219S3N	Big curved, without control vent, rigid
1229L3W	Curved 155°, with control vent, rigid
1229L3N	Curved 155°, without control vent, rigid
1229K3W	Curved 135°, with control vent, rigid
1229K3N	Curved 135°, without control vent, rigid



Flange Tip Yankauer

Product code	Description
1234X2N	Without control vent, tip O.D.4mm, flexible
1237R2N	Without control vent, tip O.D.6mm, flexible
1235V1W	Big curved, with control vent, tip O.D.6mm, rigid
1235V1N	Big curved, without control vent, tip O.D.6mm, rigid

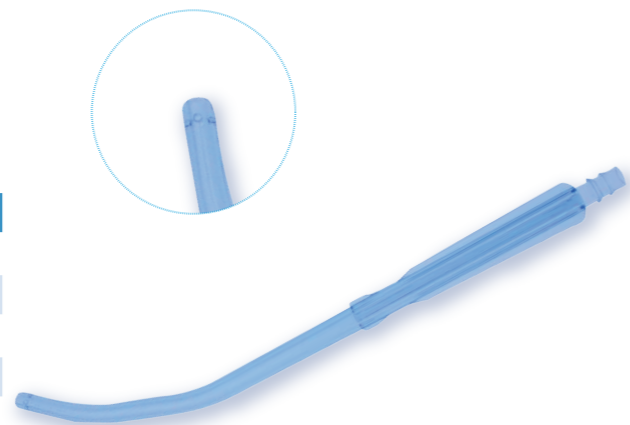

Tapered Tip Yankauer

Tapered flanges to help reduce tissue trauma with maximum visibility

Product code	Description
1215A3W	Small curved, with control vent, rigid
1215A3N	Small curved, without control vent, rigid
1215S3W	Big curved, with control vent, rigid
1215S3N	Big curved, without control vent, rigid

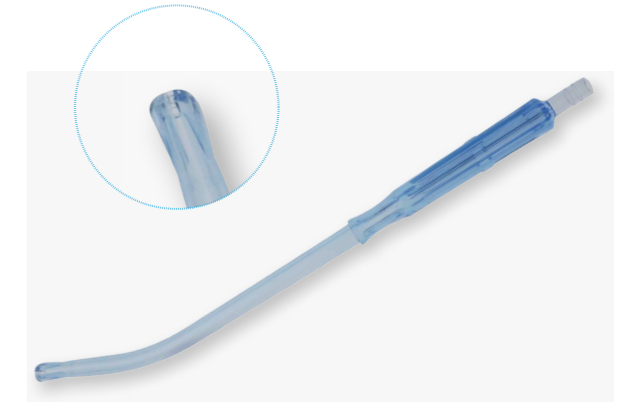

Product code	Description
1232C3W	Double curved, with control vent, rigid
1232C3N	Double curved, without control vent, rigid

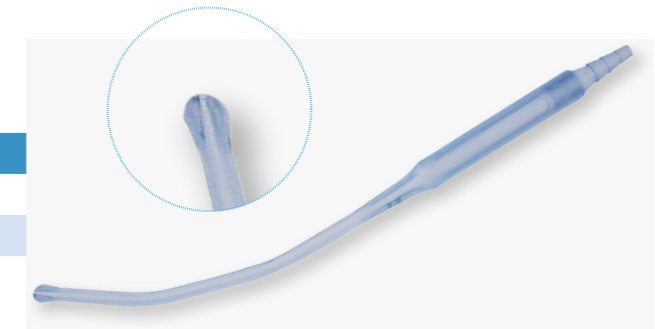

On/off Yankauer

Surgical suction cannula with switch on and off valve,

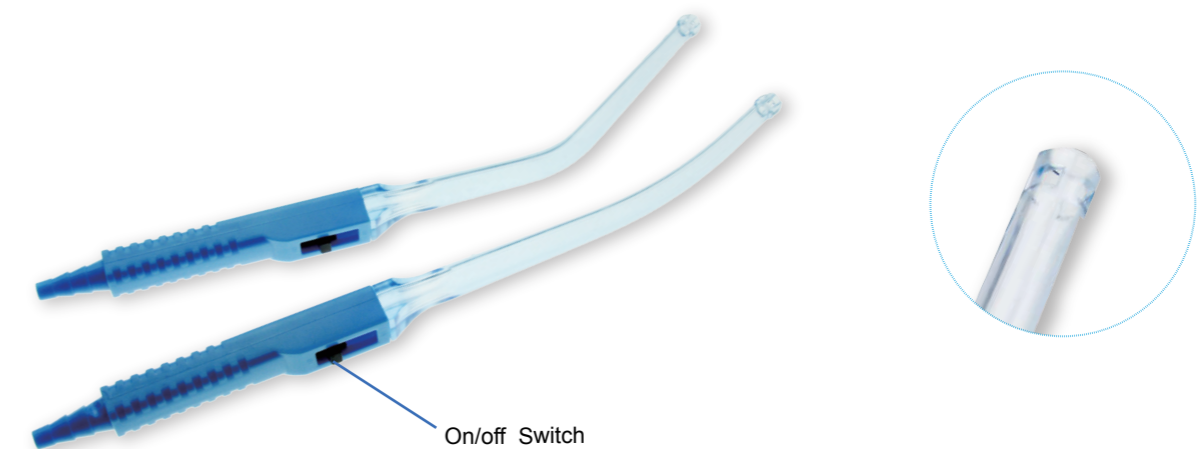

Product code	Description
1238Y3W	Curved 155°, tapered tip
1239Y3W	Curved 155°, plain tip
1238M3W	Curved 140°, tapered tip
1239M3N	Curved 140°, plain tip

Bulb Tip Yankauer

Product code	Description
1223G1W	Big curved, with control vent, rigid
1223G1N	Big curved, without control vent, rigid
1223F4W	With control vent, flexible
1223F4N	Without control vent, flexible

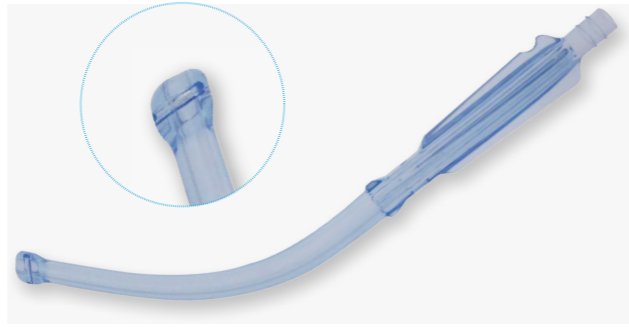

Crown Tip Yankauer

Product code	Description
1227A3W	Small curved, with control vent, rigid
1227A3N	Small curved, without control vent, rigid
1227B3W	Big curved, with control vent, rigid
1227B3N	Big curved, without control vent, rigid
1227D3W	Double curved, with control vent, rigid
1227D3N	Double curved, without control vent, rigid
1233K3W	Big curved, with control vent, rigid
1233K3N	Big curved, without control vent, rigid



Pool Suction Handle

Flexible or Rigid sump sucker with removable inner suction probe. Specifically for abdominal surgery, reducing trauma to surrounding tissues

FEATURES:

- Specially designed to evacuate pooled blood, fluid or debris during deep abdominal surgeries or cesarean suction
- Two-part tube locks for use as an assemble unit
- Removable sheath for convenience suction

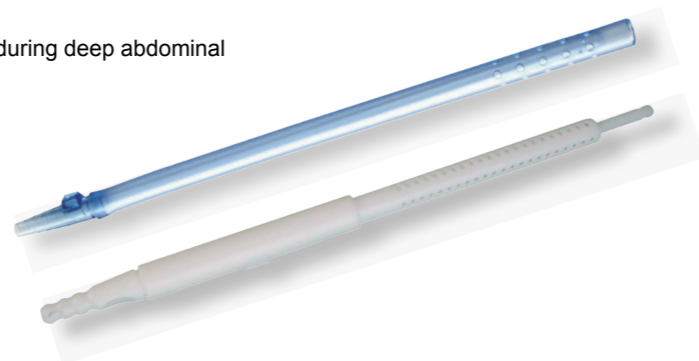

Product code	Description
1243N6N	Flexible sheath
1243N5N	Rigid sheath with 132 eyes for rapid suction

Plain Tip Yankauer

Product code	Description
1245E1W	With control vent, rigid, tip O.D. 6.7mm
1245E1N	Without control vent, rigid, tip O.D. 6.7mm
1244E1W	With control vent, rigid, tip O.D. 4.3mm
1244E1N	Without control vent, rigid, tip O.D. 4.3mm

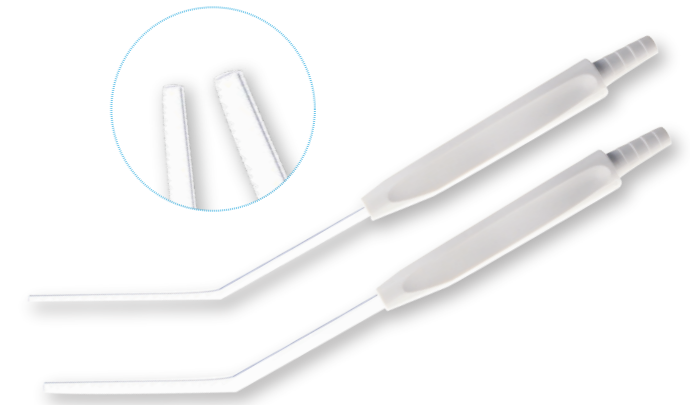

Duck-bill Tip Yankauer

Product code	Description
1248J1W	Duck bill tip with control vent
1248J1N	Duck bill tip without control vent

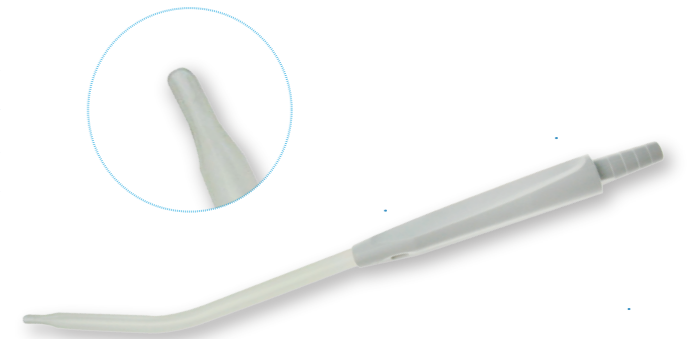

ASPIRATOR SURGICAL TIP

Surgical aspirator tips are proven aids in drying the oral field of treatment in minimally invasive surgery and in aspirating particles.

The plastic aspirator tips allow extremely accurate aspiration as the shape and design have been specially developed for working under a microscope or loupe. The tips are ideal because of their hygienic handling and ease of use.

The green tip provides excellent contrast for precise aspiration

Open field of view due to the narrow shape and conical tip

1.2mm is specially designed for use with microscopes and loupes. The extra fine tip-opening ensures precise aspiration without blocking the field of vision.

FEATURES:

- Extra length of the aspirator tips can be held at a distance from the operation area
- The fine tube and extra fine green tip ensure effective aspiration even in small spaces

Product code	Description
1246H5N	With extra O.D. 1.2mm tip
1247H5N	O.D. 2.5mm tip

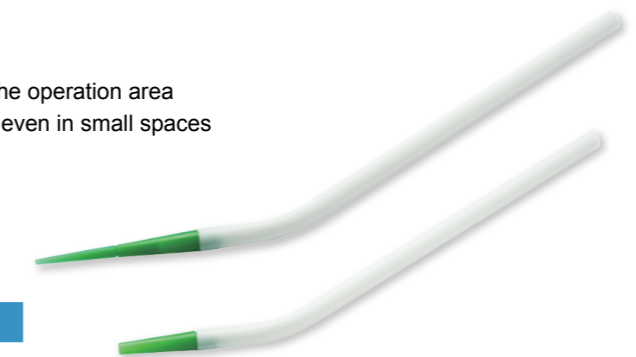

SUCTION PROBE

Suction Probe with Male Connector

For general suction purposes, orthopaedic suctioning or dental work.

FEATURES:

- Simple and economical rigid PVC suction device, used for general suction purpose
- Male connector for easily attaching to all sized suction tube

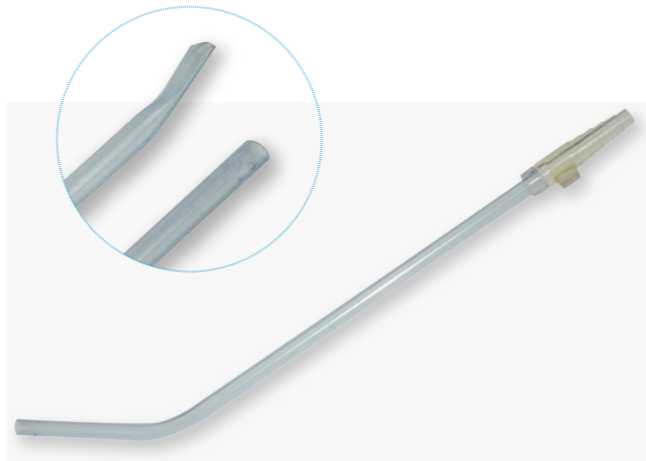

Product code	Description
1251J1N	Duck bill tip
1252J1N	Straight tip

Suction Probe-Flexible

Special disposable probes with efficient prestrol vacuum control device. Designed for neuro surgery, ENT surgery and in applications where controlled suction is required.

FEATURES:

- Flexible suction probe with vacuum control vent.
- Clear probe for easy observation.
- Flexible probe can be bent to varying shapes and angles as required.

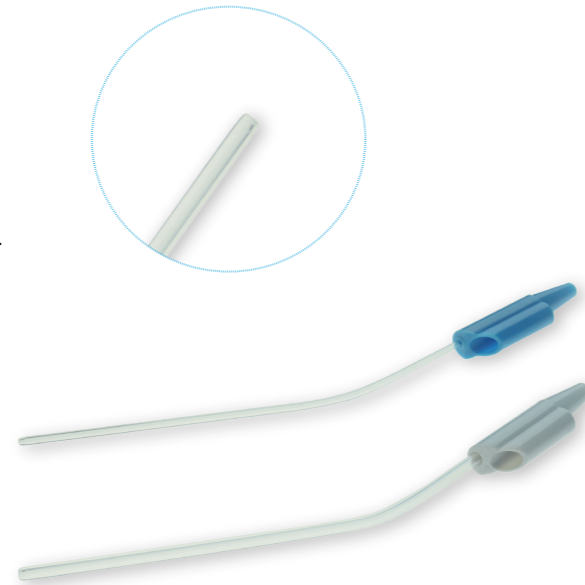

Product code	Description
1253L1W-12	Straight tip, sized Fr12
1253L1W-08	Straight tip, sized Fr08

FRAZIER SUCTION TUBE

Used in open surgical procedures where delicate suctioning is required.

FEATURES:

- Flexible cannula could be bent to needed position without occlusion
- Available with integrated transparent handle for visual check.
- Single use for neuro-surgery



Product code	Description
1242A08	Fr08, with control vent
1242A10	Fr10, with control vent
1242A12	Fr12 with control vent
1242A18	Fr18, with control vent
1241A06	Transparent handle,Fr06, with control vent
1241A08	Transparent handle,Fr08, with control vent
1241A10	Transparent handle,Fr10, with control vent
1241A12	Transparent handle,Fr12, with control vent



SUCKER INTRACARDIAC

To clear the surgical site of excess blood.

FEATURES:

- Reusable stainless steel
- Highly polished blood contact surfaces for patient safety
- Available with soft tip and rigid tip



Product code	Tip
1221S01	Soft tip, pediatric
1222S01	Rigid tip, adult

ORTHOPEDIC SUCTION SET

Easyflow Filtered suction system for orthopaedic surgery. Orthopedic Suction Set with filter keeps the operative area visible, clean, and clear. The special filter built into the handle automatically traps solid and can be exchanged in a matter of seconds when filled. Increased filter capacity makes the suction set ideal for hip arthroplasty and other procedures that produce a large amount of debris.

FEATURES:

- Non-block design decreases risk of damage to tissue and post-operative infection and complications
- Filter exchange takes only a few seconds
- Reversible suction tip available with straight or curved tip with length 15cm and 23cm.



Product code	1200A01	1200B01	1200C01	1200D01	1200E01	1200F01
Extra filter	W/O	With	With	With	With	With
Tip	15cm curved tip & 23cm curved tip	15cm curved tip & 23cm curved tip	15cm curved tip & 23cm curved tip & 23cm straight tip	15cm curved tip & 15cm straight tip	23cm curved tip & 23cm straight tip	15cm curved tip

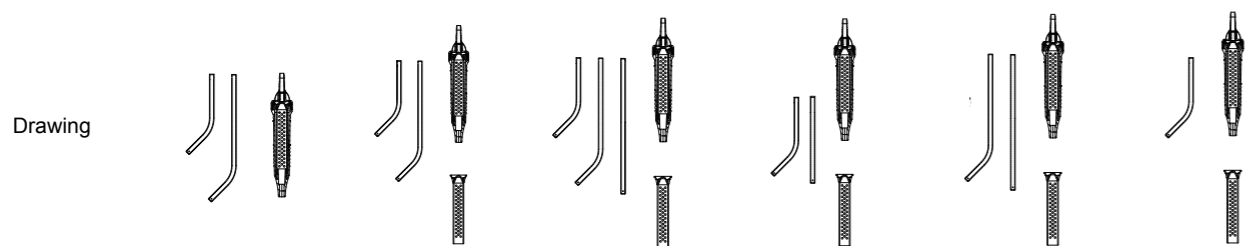

SUCTION CONNECTING TUBE

A complete system to connect suction sources to suction waste collection systems, suction catheters, yankauers, and other suction devices. We could offer a range of easily connected, interchangeable products.

FEATURES:

- GCMedica suction connecting tubes have different connectors available for doctor's preference.
- Tube diameter is sized from 3/16" to 1/4" and 9/32".
- Length can be tailored according to customer's requirements.

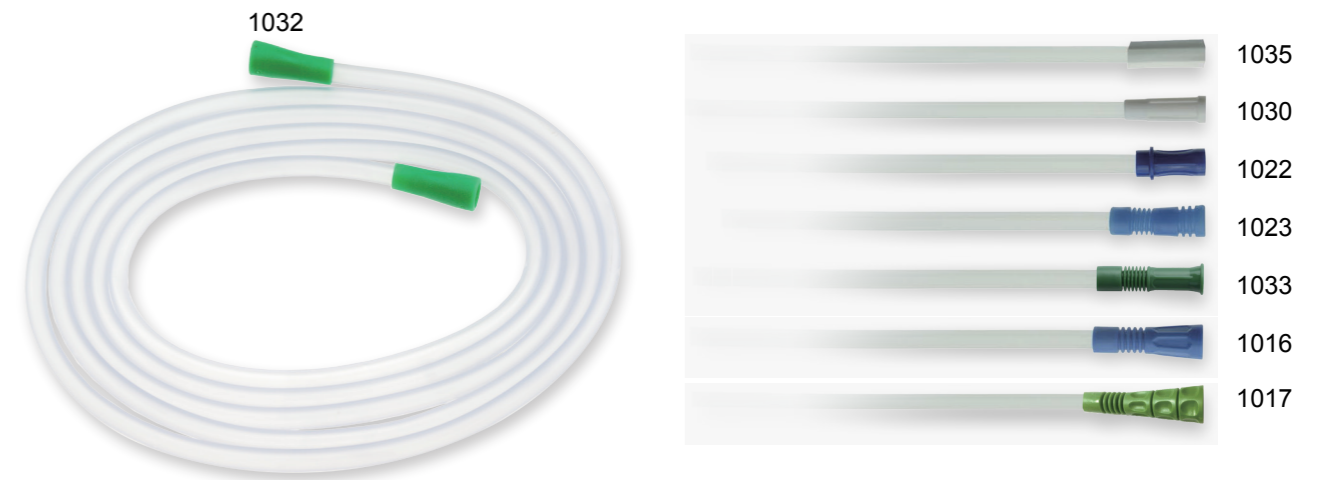

Male Connectors

FEATURES:

- Attachable to different sized tubes.
- Transparent color is available for monitoring fluids.
- Available in a variety of sizes.

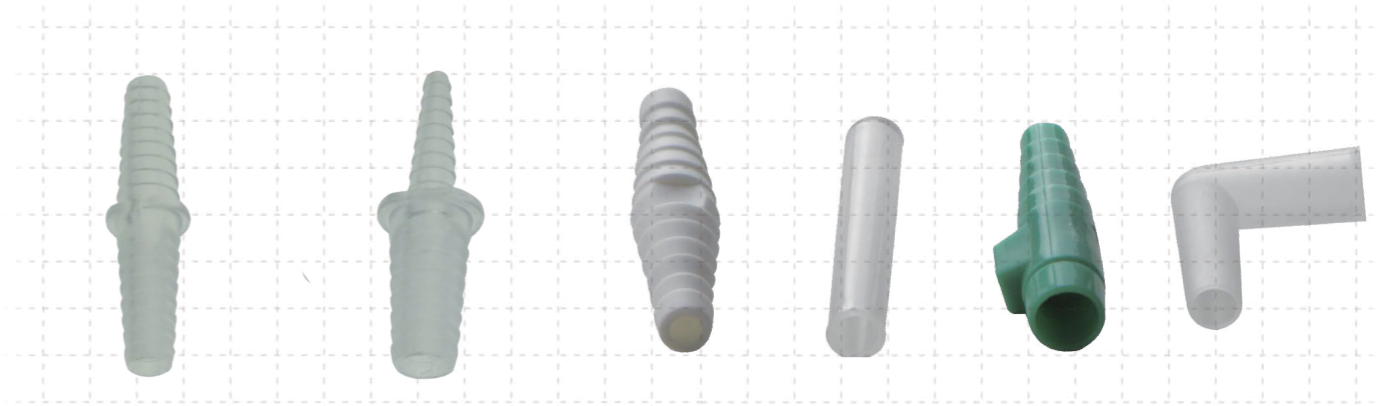

Code	O.D.	Code	O.D.	O.D. 7.3-12mm	O.D 8mm	O.D 6.8-11.3mm	O.D 6.5&11.3mm
1065	4-7mm	1068	4-7mm/7-10mm	1025	1028	1024	1029
1066	7-10mm	1069	4-7mm/10-14mm				
1067	10-14mm	1070	7-10mm/10-14mm				

Bulk Suction Connecting Tube

FEATURES:

- Clean bulk tubing in rolls that can be cut into the exact length needed.
- Cut-to-size female connectors are located at 6ft. intervals

Product code	Description
1731AIL	3/16" ID, 100ft length
1731CIL	1/4" ID, 100ft length
1731DIL	9/32" ID, 100ft length

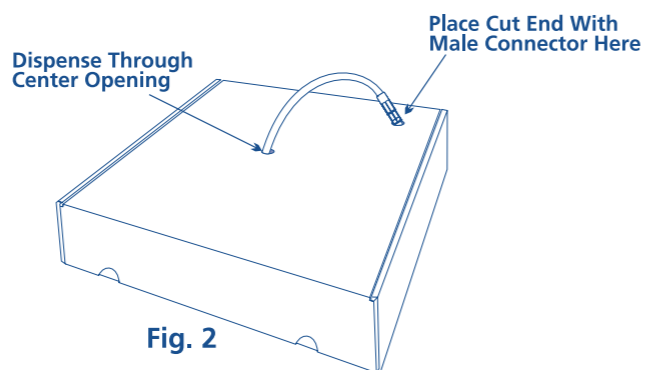
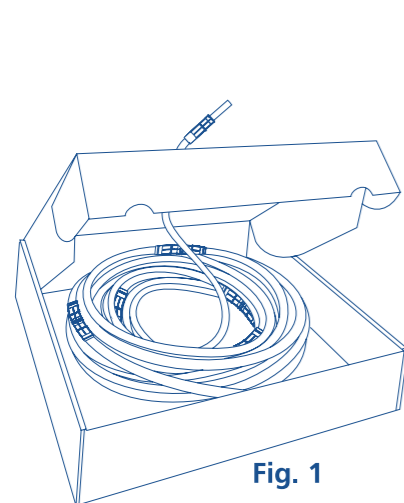
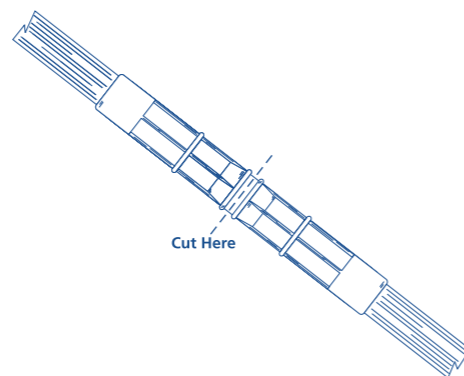

Suction Bubble Tubing

FEATURES:

- Easily cuts to desired length with scissors.
- Bubble every 36 inches.

Product code	Description
1301A05	3/16" ID, 100ft length, smoothbore tube
1301A06	1/4" ID, 100ft length, smoothbore tube
1301A07	9/32" ID, 100ft length, smoothbore tube
1302A05	3/16" ID, 100ft length, anti-crush tube
1302A06	1/4" ID, 100ft length, anti-crush tube
1302A07	9/32" ID, 100ft length, anti-crush tube

RIGID SUCTION CANISTERS

Disposable Rigid suction Canisters feature rigid blue lids with an automatic shutoff valve to help prevent cross contamination of regulators and wall vacuum outlets. Available with 90° adapters allow tubing to connect at right angles to help prevent kinking and impeded fluid flow. The locking lid encourages the proper disposal of infectious liquid medical waste and enhances worker safety. Lid includes accessory and orthopedic ports

FEATURES:

- More diverse range of sizes to better address your fluid management needs
- Available in 1,200cc, 2,000cc and 3,000cc, each featuring a hard, disposable body and lid
- Lid features a standard elbow suction port and a porous shutoff valve to prevent backflow
- Once the lid is snapped on it is locked securely in place
- These canisters are a user-friendly option due to both their transparency and ability to stand alone



Product code	Description
1957A12	CANISTER, RIGID, DISPOSABLE, 1200CC
1957A20	CANISTER, RIGID, DISPOSABLE, 2000CC
1957A30	CANISTER, RIGID, DISPOSABLE, 3000CC

SUCTION CANISTER SOFT LINERS

FEATURES:

- Part of a complete fluid management system
- A soft plastic liner that goes into a reusable canister - this means less plastic waste in a landfill and greater savings
- Available in 1,000cc, 1,500cc and 3,000cc, three convenient sizes
- Not made with natural rubber latex

Product code	Description
1941B10	LINER, SOFT, SUCTION CANISTER, 1000CC
1941B15	LINER, SOFT, SUCTION CANISTER, 1500CC
1941B30	LINER, SOFT, SUCTION CANISTER, 3000CC

